



## Clustering Methods for Identifying Key Framing Elements in Multimodal News Coverage of the Belt and Road Initiative: A Cross-platform Study

Mengyao Qi <sup>1, 2</sup>, Shahrul Nazmi Sannusi <sup>3\*</sup>, Ammar Redza Ahmad Rizal <sup>3</sup>

<sup>1</sup> Ph.D candidate, Centre for Research in Media and Communication, Faculty of Social Sciences and Humanities, Universiti Kebangsaan Malaysia, Bangi, Malaysia

<sup>2</sup> Lecturer, Literature Department, Qingdao Film Academy, Qingdao, China

<sup>3</sup> Doctor, Centre for Research in Media and Communication, Faculty of Social Sciences and Humanities, Universiti Kebangsaan Malaysia, Bangi, Malaysia

\* **Corresponding Author:** [nazmy@ukm.edu.my](mailto:nazmy@ukm.edu.my)

**Citation:** Qi, M., Sannusi, S. N., & Ahmad Rizal, A. R. (2024). Clustering Methods for Identifying Key Framing Elements in Multimodal News Coverage of the Belt and Road Initiative: A Cross-platform Study. *Review of Communication Research*, 12, 183-202. <https://doi.org/10.52152/RCR.V12.11>

### ARTICLE INFO

Received: 18 Jul 2024

Accepted: 26 Aug 2024

### ABSTRACT

This study aims to determine the effectiveness of clustering strategies in the analysis of framing aspects in MMNs with regard to the Belt and Road Initiative (BRI). This paper seeks to understand how text, images and videos help in the construction of the BRI, a major geo-political and economic undertaking spear headed by China. To this end, this study intends to use a more sophisticated clustering approach that would allow identification of the main framing constituents and their interaction in the context of the specific media segments. The method adopted in the study combines text analysis, visual content analysis and extraction of frames from the videos as a way of capturing the dimensions of news coverage. The concept of multimodal framing is vital, especially when studying how such a large-scale global project like the BRI is framed. Thinking types involve textual factors like headlines or keywords and thematic stories together with visions like images and video clips addressed to find out the patterns and frames. The research applies NLP tools for textual content, image analysis for images, and video scribes for the classification of video clips. These methods combined provide a systematic way in which the presentation of content in multifaceted media can be studied, and give evidence on the continuity and disparity of the framing within platforms. It is only when one plays the different modes of communication against one another, that the study shows how each of them contributes to the construction of the public understanding of the BRI. In doing so, the study thus offers a holistic perspective of the nature and forms of the dominant frames alongside their differences across the media; a perspective that fills the gap left by existing research regarding how all the features of multimodal composition work together to shape the audience's perception. This research contributes to the field of media and communication by proving the fact that how clustering technique is effective in multimodal analysis and how the current framework provides the foundation for future research related to the media framing that happens in the cross-media environment.

**Keywords:** Multimodal Framing Analysis, Belt and Road Initiatives, News Coverage, Clustering Method of Framing Elements, Audience Engagement.

## INTRODUCTION

With the arrival of digital technology, there are new changes in news media and media technology enables a complex delivery of text, images, videos, and audio to present multilayered realities (Gergen, Gulerce, Lock, & Misra, 1996). In particular, understanding and analyzing the multimodal framing elements becomes critical within the context of massive shifts in the global industry like China's BRI. This study aims to explore clustering approaches in the process of determining the critical framing components of the BRI news articles in different modes; this study will provide useful findings to the journalists, mass media practitioners, policymakers, politicians, academicians, scholars, and non-governmental organizations (Hafez, 1999). Integrated framing materials in the media have a central function in how the public comprehends and reasons through contemporary intergovernmental initiatives such as the BRI. It was established in October 2013 and seeks to support economic integration, the improvement of trade connections, and the establishment of infrastructure necessary for Asia's and the world's growth (Wilcox, 2003). Since the BRI is a large-scale project that has influenced a vast number of global citizens, it has elicited much media attention all over the world. This work found out that the BRI is depicted in the news media through textual content, images, infographics and video clips making up a complete story in shaping peoples' perceptions and policy makers' decisions. To journalistic and media practitioners, the capability to recognize and decompose the multimodal framing elements is crucial in reporting the news fairly and accurately (Matsumoto, 2007). Seeing how the items are grouped and delimited enables media practitioners to revolve around the constituents and give the population more valuable and objective interpretations of such global projects as the BRI. In return, this research offers them enhanced instruments and approaches to analyze the detailed structure of the news content and identify concealed prejudices and framing strategies which could remain beyond the audience's notice (Hindle & Klyver, 2007). Policymakers and heads of government are also likely to benefit a great deal from this kind of research. It was found that the approach taken to reading the BRI in media can help determine the public reception towards the project and change diplomatic and trade ties. Such a result indicates that through applying the clustering methods for the analysis of the news coverage, the policymakers can obtain a more profound understanding of the currently popular narrative and sentiment regarding the BRI (Katz & Lai, 2009). Knowledge of these attitudes can be useful in public relations and policy action to get the word out on the relevancy and benefits of the particular nowadays announced initiatives. Media and communication scholars and researchers interested in the concepts of framing or multimodal analysis may apply the findings of this research to enhance the theories and methods used in their discipline (Meier, 2009). The use of clustering methods in the multimodal contents analysis is a major step forward in investigating innovative approaches and solutions for media narrative analysis. As a result, this research extends the existing academic knowledge by offering qualitative information and methodologies that can be utilized in other research fields in addition to the BRI. Thus, civil society organizations can use the findings of the present research to promote the necessity of increased transparency and media diversity (Yuan, 2011). Awareness of how the said multimodal elements are employed in heralding the BRI helps these organizations decode possible biases that are embraced and enhance media literacy within the general population. Thus, civil society organizations are able to serve as watchdogs for the media and create a more informed public that demands a proper presentation of the subject in question (Moturu & Liu, 2011). All in all, the result of this study about clustering methods for the analysis of key framing elements in the multimodal news of the Belt and Road Initiative provides suggestions and tools for not simply the academics and researchers, but also the media outlets and policymakers (Ren, Dong, Popovic, Sabnis, & Nickerson, 2024). Through shedding light on multimodal framing in media, this study improves the knowledge and practices of journalists, media practitioners, policymakers, government politicians, scholars, researchers, and NGOs in the sphere of international news media (Chyi & Chadha, 2012).

The parameter of this research involves a determination of clustering techniques for framing analysis on the BRI news coverage that features multiple modes. It is especially interesting to know how different media outlets engage in multimodality (text, images, videos, etc) in constructing and representing the BRI. This research is intended to be of paramount assistance to practicing journalists and other members of the media fraternity to have insights on the techniques to adopt in framing. Anyone interested in understanding how the concept of the BRI is disseminated through media to the audience will find the information provided helpful in this pursuit. The improved and innovative clustering techniques that have been described in this study will be of importance to the academic and research fraternity particularly for multimodal analysis. Media representations of the BRI are also relevant to civil society organizations since it helps in understanding the narratives that are circulated in the media so that they could improve the advocacy work involving the public.

The gap in the present literature relates to the lack of an extensive study on the different modalities of framing elements within the coverage of the BRI. As for what previous research has focused on, although there are

bodies of work that analyze textual framing or visual framing in isolation, there seems to be little effort directed towards taking all these various frames collectively and assessing how they come together to create representations of the BRI across various platforms of media, be it texts, images, videos, etc. Analyzing these multimodal framing techniques would help in expanding the field of media and communication research as it would elucidate how different media blend different components and shape the perception of the public and the corresponding policies. It is even more crucial for the media scholars who investigate the manifold nature of contemporary news production and consumption and/or for the practitioners in search of successful communication strategies for engaging with the media discourse on large-scale global projects such as BRI.

Here are some research objectives are given below to support the study:

- To develop and apply clustering methods for the identification and analysis of multimodal framing elements in news coverage of the Belt and Road Initiative (BRI) across diverse media platforms.
- To assess the effectiveness of multimodal framing strategies in shaping public perception and policy discourse related to the BRI, providing insights relevant to journalists, media professionals, policymakers, and government officials.
- To provide recommendations for enhancing media literacy and strategic communication practices among journalists, policymakers, academics, researchers, and civil society organizations based on findings from the analysis of multimodal framing elements in BRI news coverage.

## **LITERATURE REVIEW**

Multimodal framing elements in media and communication research apply techniques for clustering, which allows to definition of the primary aspects of the news. Hence, by deciphering the text, images, and videos across multiple social networking sites, scholars wish to establish how various media frames affect the public sentiment toward various programs such as the BRI.

### **Media Trustworthiness**

In the context of postmodern media communication with global information flow, the study of identification and analysis of Multiple Framing Elements are significant in relating and comprehending the nature of information construction and receiving arenas. In particular, research carried out in constructing these clustering methods for identifying these specific framing elements, which are defined in the article “Clustering Methods for Identifying Key Framing Elements in Multimodal News Coverage,” helps in understanding the trustworthiness of media (Hiltz & Gonzalez, 2012). Multimodal framing elements include rhythms of visual, textual and audiovisual encompassing a broad spectrum through which the public’s perception and understanding of news is shaped. For journalists and media professionals, these elements present a more sophisticated way of reporting which helps to avoid simplification of the object. If journalists use different modalities, the audience will trust the information more as the excess of biased information is frustrating the audience now (Pavelka, 2014). Government policymakers and officials can benefit from such research as it provides information on how policies and related initiatives are formulated across the various media based platforms. Knowledge about multimodal framing is useful for creating better communication strategies and predicting public reception. Both scholars and researchers see benefits in the study of clustering methods because it enhances the development of media analysis techniques (Pavelka, 2014). Such analysis allows for furthering the understanding of the media narratives and the patterns that occur in them, thus having implications on the ways in which people are framed and discussed in society. CSOs use these findings in their campaigns for media literacy and indeed media accountability. They can build on the knowledge of multimodal framing for the improvement of citizens’ ability to distinguish between real and fake news (Lee & Yang, 2014). In sum, studies on multimodal framing elements contribute to multiple layers of theoretical discussion and enlighten different stakeholders of societies to improve more comprehensive participation in public debate enhancing democracy and social cohesiveness (Heikkilä & Ahva, 2015).

### **Multimodal Framing Elements**

Having the development of this study, it can be concluded that multimodal framing elements play a crucial role in the construction of narratives and in the management/control of public perception in today’s media and communication environment (Ahva & Hellman, 2015). There is a clear testament to this transformative function in the studies that focus on clustering approaches in the determination of framing ingredients and approaches in the multimodal news coverage of practices like the BRI. Words are less important, although they are still present; the focus is on graphic images which convey the nature of intricate processes in international relations (Debras & L’Hôte, 2015). Think about the picture consisting of the scenes illustrating trade routes, construction of buildings

and bridges, cultural interactions with people all over Eurasia. Besides, these visuals not only educate but also arouse different emotions to unite journalists and media professionals across geographical and cultural backgrounds who are attempting to explain various social implications of the BRI (Wozniak, Lück, & Wessler, 2015). They are complemented by video material that adds the value of ceremony and creates the atmosphere of presence at the BRI projects' implementation. These videos featuring high velocity rail lines across terrains, interviews with the local people give information and perspective that can directly influence policymakers making definitive decisions on cooperation with international governments and organizations and formulators of economic policies (Hopmann, Shehata, & Strömbäck, 2015). Infographics take large amounts of data and present it in a form that will support the analytical thought process of the academic or researcher, which can help assess the pattern of media coverage on BRI (Pentzold, Sommer, Meier, & Fraas, 2016). This awareness of the indicators by underlining the contours of the framing themes: the economic potential, the environmental risks, and the geopolitics of/of the measures that inform the discourse of civil society organizations that demand accountability and transparency (Ross Arguedas et al., 2024). Utilizing multimodal framing elements, media and communication specialists not only report but constructively build global perspectives on projects such as the BRI, guide the way that people, governments, or organizations perceive, decide or act on such a project (Wessler, Wozniak, Hofer, & Lück, 2016).

### News Source Platforms

In the context of the dynamically developing area of media and communication, the investigated methods of clustering to determine the components of framing in multimodal news are essential, especially in the coverage of the BRI. This study focuses on the multifaceted relations between the text, images, and sounds throughout the social media platforms to understand the mechanism of how different media sources work (Schwanholz, Graham, & Stoll, 2017). Consequently, it is crucial for journalists and other workers in the media industry to have deep insight into multimodal framing elements in order to establish more realistic and progressive perceptions of the events occurring in the world. Through clustering techniques, the journalists can discern the overall focus and tone present in the news which increases the coverage relevance and scope (Barkemeyer et al., 2017). As for the policymakers and government officials, they can benefit from this study by getting to know how BRI is presented across the different media platforms. Such knowledge makes them understand the perception of the public, the likely misunderstanding to expect and how to convey a certain policy in specific discursive ways. Scholars and researchers benefit from the desire to use the clustering methods to analyze which brings about the developments in the methodological approaches within media studies and in the field of communication sciences (Zhang & Gupta, 2018). This research promotes a better perception of how media impulse and shapes social perceptions and politics concerning global activities such as BRI. Media consumers, civil society organizations, and the government can employ these findings to demand decency in the coverage of the matter and clear facts from the media (Ferrer-Conill & Tandoc, 2018). Thus, it may encourage critical media consumption awareness and apply adjustments when framing news to avoid such biases or provide equal coverage across the platforms. Therefore, the analysis of the different clustering methods applied to the multimodal news framing in the case of the BRI has significant benefits from different perspectives. Thus, their work highlights the need for methodological creativity in media studies, as well as global actors' collective contribution to constructing and interpreting narratives (Lawrence, Radcliffe, & Schmidt, 2018).

### Cultural Context

Understanding the features and changes in contemporary news media systems involving multimodal news texts and initiatives such as BRI is critical, which is why research on clustering methods for identifying key framing elements in such contexts is essential to its theory and practice for various stakeholder groups (Altay, Nielsen, & Fletcher, 2024). In the recent past, the BRI has attracted significant international interest because of its expansive vision and its political impact to become the area of interest preferred by the attention of the media of various types (Meier, Kraus, & Michaeler, 2018). In this regard, different modes of framing such as textual, visual, and auditory are critical in the formation of public opinion and policy discourse pertaining to various mega initiatives like BRI. To journalists and media specialists, these elements reveal a more subtle approach to codification of certain visual geopolitical information, which can help to shape collective opinions and, therefore, political strategies (Zheng, Zhong, & Yang, 2018). By applying clustering analysis, these elements can be analyzed with regard to how they are being assembled and delivered through the media, thus enhancing our understanding of the formulated media framing approaches and their effects. Government and policymaking bureaucracies can also benefit from such research by getting acquainted with how media contributes to the formation of political opinion as well as diplomacy (Westlund & Ekström, 2018). Understanding multimodal framing can help tailor the communication in speeches, posts, and articles in the run-up to the events tied to those strategies and facilitate policy-making when it comes to such large-scale projects as the Belt and Road Initiative. Analysts and scholars benefit from the consultation of clustering methods as these aid in the development of media and communication

theories, specifically multimodal analysis (Wallace, 2018). Thus, by applying methods of clustering and analyzing which channels act as BRI's source and which ones focus on it, researchers can expand the discussion on the role of media and agenda-setting (Tong, 2023). Civil society organizations should benefit from this research as it offers those ways of critically engaging with the media representations of the BRI and other similar endeavors, and ways of pressing for accurate and balanced coverage (Osatuyi & Hughes, 2018). Framing elements in multiple modes of knowledge helps civil society to engage in a constructive dialogue with all interested parties and hence society can be able to compel the media houses to embrace ethical and accurate journalism (Nelson & Lei, 2018).

### **Audience Engagement**

In the contemporary context of constantly progressing media, it is vital for individuals working in the field of journalism and media to comprehend the factors of multimodal framing if they are to offer global perspectives. The investigation of the clustering methods used for finding the above mentioned elements in multimodal news reporting on initiatives such as Belt and Road is instrumental (Cedillo, 2018). In this way, journalists taking into account the textual, visual, and video material do not only identify various causes but also reveal different aspects of the given concern. In this respect, it should be significant for policymakers and government officials to note that communication is not simply a question of broadcast but of strategy. Usually, actor orientations and frames matter a lot in policy implementation because they influence the implementation of initiatives across various media (Cvetkovic & Pantic, 2018). Through the use of multimodal analysis, officials on the other end are able to determine similar attitudes from the public, and in the process modify the message to make them adopt the endeavors as noble and worthy of support. Researchers and academicians can benefit from this study as these findings contribute to the enhancement of methods of media analysis (Grimmelikhuijsen, De Vries, & Zijlstra, 2018). It provides an identifiable model for analyzing cross-platform and multi-method communication data, which leads to the development of more advanced methodological investigation in the field. Thus, analyzing the interrelations between text and images in more detail will allow the identification of hidden stories and contexts within the coverage. Civil society organizations also have their relevance in this research (Belair-Gagnon, Nelson, & Lewis, 2019). This knowledge of multimodal framing assists advocacy groups in moving in the media geography to enhance their messages. By understanding how information is communicated through the various channels of communication, one can effectively target different audiences and spread the word on various causes (Broersma, 2019). Altogether, the theoretical and empirical study on clustering methods for multimodal framing elements contributes to academic literature as well as international and other stakeholders by providing them with the necessary tools to better understand and shape the framing processes across society (Dancygier, 2023). If viewed as a compass in the field of media and communication it points towards the directions that can engender the production of deeper as well as more meaningful knowledge among professionals as well as academicians involved in the communication field (Annamoradnejad, Fazli, Habibi, & Tavakoli, 2019).

### **Hypothesis Development**

The hypothesis built upon the research in the multimodal news coverage of the B&R projects underscores that with the help of sophisticated clustering, it is possible to recover the various, yet related, framing elements of various media sources. Consequently, this approach shall help the following stakeholders; journalists, policymakers, academics, and civil society since it helps improve the understanding of the distinct media portrayal, and the potential societal effects.

**The Effect of Multimodal Framing Elements (Visual Imagery, Video Content, Infographics), New Source Platforms and Cultural Context on Media Trustworthiness**

The combination of the framing elements in the present day media has significantly altered the way that the information is presented to society. Visual imagery, video content and infographics become important not only supplementing the possibilities of the word in the journalistic narration, but also forming the possibilities of the consumption and appreciation of news by various audiences (Ionel & Alexandru-Gabriel, 2019). It is therefore important for journalists and any other media personnel attempting to sharpen his or her skills in narrating stories and remain relevant in this modern world. Photographs and illustrations as well as other forms of graphics help the audience to experience emotions and or give them a reality check of real life situations pertaining to the news (Jungblut & Zakareviciute, 2019). Text, nevertheless, provides static information that gives the audience a textual and written account of the happenings while video content presents moving images that not only inform but also entertain the viewers through sound, movement and visual appeal closing the gap between information and audience reception (Ramírez, 2023). Infographics then provides a means for the condensation of large amounts of data into easily manageable graphics that make the otherwise intricate details easily visible and intelligible (Halfmann, Dech, Riemann, Schlenker, & Wessler, 2019). In records, for policymakers and other government officials, awareness of multimodal framing elements is rather central in opinion and policy making. Therefore, when these elements are well developed, the governments can pass the message effectively and

efficiently to their respective populaces, making the populace embrace the government's agenda and policies (Gajardo & Costera Meijer, 2023). Scholars and researchers on framing emitted benefits from the current study on using different modes of presentation to understand the nature of the presentation-perception nexus (Steensen, Ferrer-Conill, & Peters, 2020). In practical contexts, methodologies of research, including those included in articles such as "Clustering Methods for Identifying Key Framing Elements in Multimodal News Coverage," are helpful in identify various aspects and elements influencing the narratives and the audience's trust. Multimodal framing is employed by civil society organizations so as to enhance the advocacy systems and the awareness that they create regarding various issues (Wonneberger, Meijers, & Schuck, 2020). This way, such organizations are able to harness people's support for their causes and become forces to reckon with within society due to their ability to create narratives that are visually and interactively enhanced (Mihelj, Kondor, & Štětka, 2022). Altogether, it can be concluded that the application of multimodal framing elements in media contributes to the central issue of communication effectiveness in different sectors (Xu et al., 2020). It can prove especially beneficial for everyone from journalists to policymakers, academics to civil society organizations, understanding and utilizing these elements can contribute greatly toward increasing media credibility, enhancing public awareness and the achievement of collective social goals. With the evolution of today's media technology, the adoption of multimodal communication strategies is always preparatory to effectively engage today's trending media platforms (Geers, 2020).

H1: Multimodal framing elements have an impact on media trustworthiness.

H2: New source platforms have an impact on media trustworthiness.

H3: Cultural context has an impact on media trustworthiness.

The Effect of Multimodal Framing Elements (Visual Imagery, Video Content, Infographics), New Source Platforms and Cultural Context on Audience Engagement

Visual narrative tools, which comprise pictures, video clips, and infographics, are the determining factors in the reception of news content, especially when addressing multifaceted phenomena, such as the BRI (Torrent et al., 2022). All of these elements have made the pieces of information understandable and shared across different social media platforms, news websites, and multimedia facilities that have altogether transformed the way information distributed and received in the current society (Faustini & Covões, 2020). For journalists as well as any other media professionals, the concept of multimodal framing helps to present complex narratives in the best way possible. Photographs and illustrations, for example, can depict the laid-out projects and bring the abstraction that is BRI closer to people. Going hand in hand with the textual and audio content, video makes storytelling more engaging and helps the target audience develop empathy and understanding of the concentration situation (Hu, 2020). Since infographics are brief and incorporate graphical illustrations of facts and figures, they help to explain such facts and figures to the target audience and to make those appealing and easier to remember. Among policymakers and government officials, there is a pluralistic utilization as it helps to explain lines of policy and their outcomes (Kim et al., 2022). Thus, with the help of bright and interesting images and successful videos, policymakers can attract the attention of citizens and stakeholders and, therefore, gain support or address relevant issues related to BRI projects (Alonso Belmonte & Porto, 2020). Office graphics are useful as brief guides for policy objectives and projects achievements that contribute to information decision-making. Scholars and researchers incorporate the categorization of framing to incorporate multiple elements of communication to share knowledge and ideas with the public. Infographics of data increases the usability of research results by translating it into the layman's language, distinguishing it from academic work (Berhanu & Raj, 2020). As a result, video content enables researchers to present methodological approaches and findings in appealing ways, encouraging the use of findings for discourses and cooperation. CSOs employ the use of multimodal framing to sensitize and advocate for change on prevalent social issues concerning the BRI. Engaging visuals and strong videos increase advocacy and engage people and communities to partake in necessary activities (Chauhan & Hughes, 2020). Infographics also educate and enlighten the communities to engage in decision-making processes and to check on the stakeholders. Civil society organizations use multimodal framing to educate the public and campaign on issues related to the BRI. Stimulating graphics and potent clips enhance advocacy actions, rallying the targeted community's support as well as boosting engagement. Thus, infographics are informative and help to fill communities with the knowledge to engage in decision-making processes with reference to certain stakeholders (Gierth & Bromme, 2020). Therefore, the mediated multimodal framing of the BRI strengthens media connection and interaction with people of diverse demographics and assists journalists, policymakers, academicians or any social organization in their own reaches of conveying, educating and persuading the public. It does not only enhance the culture of the public and the way people discuss issues but also helps in building a knowledgeable and active global society (Zayani, 2021).

H4: Multimodal framing elements have an impact on audience engagement.

H5: New source platforms have an impact on audience engagement.

H6: Cultural context has an impact on audience engagement.

#### Audience Engagement as a Mediator

It is essential to comprehend the logic of the multimodal framing elements in the context of the constantly changing media and communication environment for journalists, policymakers, researchers, and civil society actors. The studies of the clustering approaches for the detection of these elements in the news discourse of such initiatives as the Belt and Road offer a good reference for the practical analysis (Nelson, 2021). For the readers and the media consumers, this study provides direction on how to improve the narratives and the reporting done by journalists and the media (Wijenayake, Hettiachchi, Hosio, Kostakos, & Goncalves, 2021). Realizing how various media integrate texts, pictures, videos, and the like in setting up the context of stories allows journalists to set up captivating and informative narratives. This deeper understanding enables them to target the audiences and appeal to them appropriately as well as ethically appealing the information as per the modern-day requirements (Nwankpa, Ezeji, & Chile, 2021). The findings of this research are equally significant to policymakers and government officials considering the changes it brings to the taxation of cross-border income. It enlightens one on the constructive social realities of media coverage as well as policy constructivism (Blassnig & Esser, 2022). Hence the understanding of multimodal framing can enable officials to better plan how best to communicate the policies and the initiatives they have set out (Ng & Tan, 2021). They can also gauge possible reactions from the public and be able to act before such reactions can arise, this in turn enhances trust. By the completion of the research study, scholars and researchers deem it significant for the development of media theory and research approaches (Bhuiyan, Whitley, Horning, Lee, & Mitra, 2021). Thus, it creates not only a precedent in terms of the approach to interdisciplinary research and application of data analysis in the sphere of media studies. Thus, this strategy adds new value to academic discussions on communication and media framing that can create further advancements in knowledge development and cooperation in the future. CSOs that are concerned with public health and want the public to be more knowledgeable and wise insist on this research when teaching people about the need to be wise when consuming media products (Guess, Aslett, Tucker, Bonneau, & Nagler, 2021). Knowing how these frames present information enables them to work with the public and the policymakers in the right manner. Hence, they can bring to light some significant ideologies that may not be in the limelight or defy certain prominent paradigms, which can enrich society (Pflaeging & Stöckl, 2021). Lastly, the study on the multimodal framing elements regarding the news about Belt and Road makes sense to call for action across various sectors. Whether improving the practice of journalism, supporting government decision-making, contributing to knowledge, or strengthening society's voice (Ryan, 2021).

H7: Audience engagement has an impact on media trustworthiness.

H8: The impact of multimodal framing elements could be reduced upon media trustworthiness when we introduce audience engagement as a mediator in this relationship.

H9: The impact of new source platforms could be reduced upon media trustworthiness when we introduce audience engagement as a mediator in this relationship.

H10: The impact of cultural context could be reduced upon media trustworthiness when we introduce audience engagement as a mediator in this relationship.

On the basis of this evidence, we proposed our hypothesis on this framework which shows the relationship in **Figure 1**.

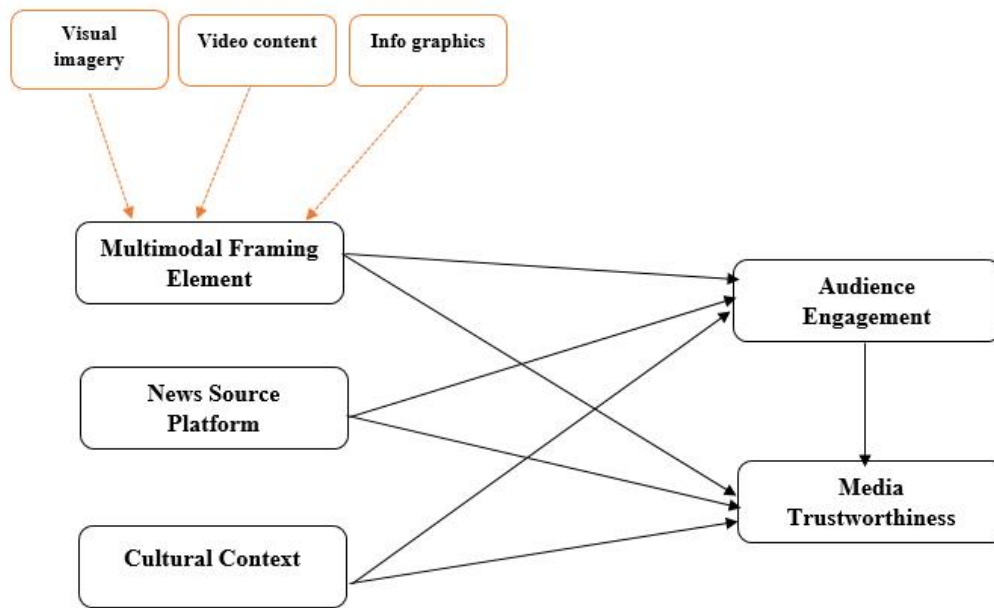

**Figure 1.** Conceptual Framework

## METHODOLOGY

The application of specific methodology to a given study can be considered to be a crucial and essential aspect of the research since doing so shows how exactly science fosters the realization of objectives and goals. The analysis parameter can be described in terms of expectation, data, observations, priority knowledge, beliefs, and course observations of the behavior of the respondents. Two broad operations are called under the label of research such as discovery and interpretation.

### Research Design

In this process what is involved is mediation and description which help in addressing the problem. Research can focus interventions at the cognitive level that concerns thoughts, emotions, or even impulses or actions. It built a mutual feedback system with its peers and garnered self-knowledge about itself. A more exciting application of the analysis is when it is used on two or more different variables, such as creative methods. In data collection for a quantitative analysis, there is the use of self-administered questionnaires.

### Study Population

The present research is from several journalists and media professionals, policymakers and government officials, academics and researchers and civil society organizations as participants. This study setting also adopts this particular population as they are relevant and important while respecting the purpose of this study. The information is gathered with the help of multiple sources, both traditional Internet ones and other means. Three hundred and fifty participants have been sent the questionnaire out of which only 400 participants responded resulting in a 87.5% response rate. The method of sampling is convenient sampling as indicated in the study. In this study, the researcher used a cross-sectional design of a structured questionnaire to collect data.

## RESULTS

Data is analyzed in three steps: Before conducting the factor analysis, in Step 1, Exploratory Factor Analysis was done on the scale to validate the number of factors using the Maximum likelihood and Varimax rotation by applying the technique available in SPSS 24. Therefore, the second step was to further validate the factor structure obtained from EFA and this was done by conducting CFA using AMOS 24. The final step was to test the hypotheses, which involved evaluating the results of the structural model using AMOS 24.

### Exploratory Factor Analysis

Principal components analysis with a Varimax pattern rotation is employed for the examination of the



structure of factors and the inter-item correlation of the measure included in the scale. The results of KMO and Bartlett's Test are provided in **Table 1**.

**Table 1.** KMO and Bartlett's Test

<b>KMO and Bartlett's Test</b>		
Kaiser-Meyer-Olkin Measure of Sampling Adequacy		0.918
Bartlett's Test of Sphericity	Approx. Chi-square	8562.302
	df	528
	Sig.	0.0001

**Table 1** presents results from the Kaiser-Meyer-Olkin (KMO) Measure of Sampling Adequacy and Bartlett's Test of Sphericity, both assessing the suitability of data for factor analysis. The KMO value of 0.918 indicates a "marvellous" level of sampling adequacy, suggesting that the data is highly suitable for factor analysis. Bartlett's Test of Sphericity, with a chi-square value of 8562.302 (df = 528, Sig. = 0.0001), shows that the correlations between variables are significant and the correlation matrix is not an identity matrix. Together, these results confirm that the dataset is appropriate for factor analysis.

**Confirmatory Factor Analysis**

Arbuckel notes that AMOS version 24 is normally used to do the Confirmatory Factor Analysis as done in this study. To check the reliability of this model it is examined related to the construct validity by testing the convergent validity and discriminant validity. Below is **Figure 2** final CFA model on CFA draw and the model calculated at the end as shown in **Table 2**.

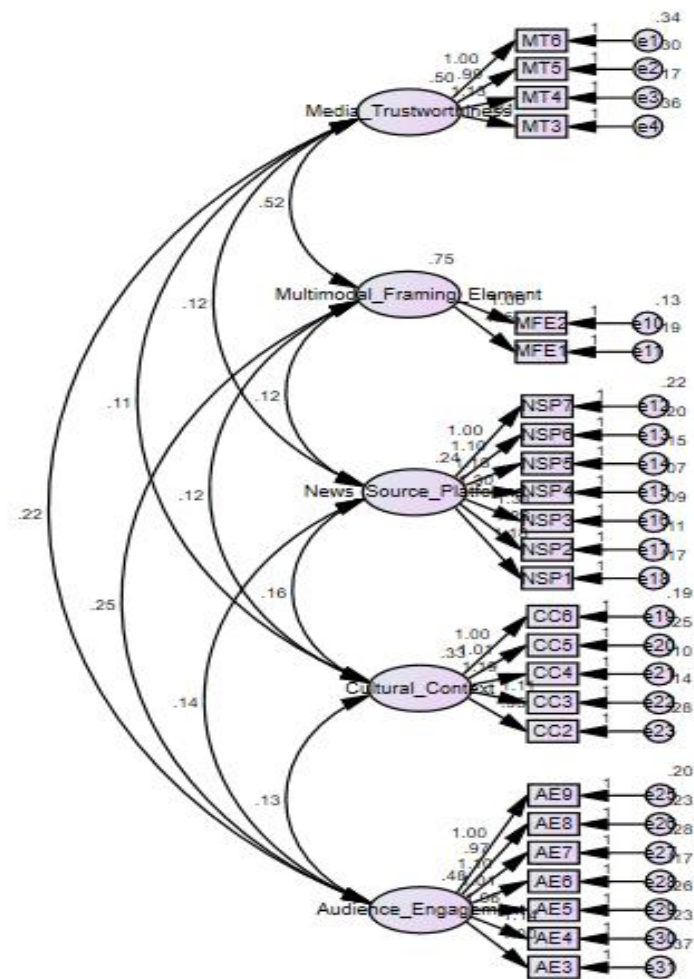

**Figure 2.** Final CFA Model

**Table 2.** Reliability and Convergent Validity

Variables/Constructs	Items	Standardized Factor Loadings	Cronbach Alpha	Composite Reliability	Average Variance Extracted	Average Shared Variance
Media Trustworthiness	MT6	0.77	0.862	0.864	0.616	0.279
	MT5	0.784				
	MT4	0.886				
	MT3	0.688				
Multimodal Framing Element	MFE2	0.922	0.898	0.900	0.818	0.262
	MFE1	0.886				
News Source Platforms	NSP7	0.72	0.94	0.942	0.701	0.176
	NSP6	0.769				
	NSP5	0.833				
	NSP4	0.924				
	NSP3	0.905				
	NSP2	0.879				
Cultural Context	CC6	0.798	0.903	0.905	0.658	0.141
	CC5	0.757				
	CC4	0.908				
	CC3	0.861				
	CC2	0.718				
Audience Engagement	AE9	0.839	0.935	0.937	0.682	0.160
	AE8	0.816				
	AE7	0.825				
	AE6	0.863				
	AE5	0.822				
	AE4	0.858				
AE3	0.752					

**Table 2** presents the psychometric properties of five constructs: Media Trustworthiness, Multimodal Framing Element, News Source Platforms, Cultural Context, and Audience Engagement. Each construct is measured by several items with high standardized factor loadings, indicating strong relationships between items and their respective constructs. The constructs show excellent internal consistency, with Cronbach's Alpha values ranging from 0.862 to 0.940, and composite reliability (CR) values above 0.864, indicating high reliability. The average variance extracted (AVE) for each construct is above the recommended threshold of 0.50, suggesting good convergent validity. Additionally, the low average shared variance (ASV) values confirm good discriminant validity. Overall, the constructs are reliable and valid for factor analysis.

**Table 3.** Discriminant Validity

Cultural Context	Media Trustworthiness	Multimodal Framing Element	News Source Platforms	Audience Engagement
0.811				
0.265	0.785			
0.242	0.859	0.904		
0.577	0.340	0.286	0.837	
0.322	0.440	0.410	0.416	0.826

**Table 3** assesses the discriminant validity of five constructs: Cultural Context, Media Trustworthiness, Multimodal Framing Element, News Source Platforms, and Audience Engagement. The diagonal values represent the square roots of the average variance extracted (AVE) for each construct, while the off-diagonal values are the correlations between constructs. For discriminant validity, each construct's diagonal value should be higher than its correlations with other constructs. The results indicate that most constructs demonstrate good discriminant validity, as their AVE square roots exceed their inter-construct correlations. However, Media Trustworthiness and Multimodal Framing Element have a high correlation (0.859), slightly higher than Media Trustworthiness's AVE square root (0.785), suggesting some overlap between these two constructs. Overall, the constructs are largely distinct and well-measured.

### Hypotheses Testing (Structural Model)

Please the analysis of big data analytic techniques, innovation strategies and audience satisfaction - Factor structure, Reliability and validity, and Research model for the Structural Equation Modeling Analysis for measuring the relationships studies were estimated using the AMOS path analysis by imputing the Factor Score from CFA using AMOS. During hypothesis testing the content creation was established as a mediator. Below is the structural model that is followed by the Actual Results Actual Mean Square and the Expected Results in **Figures 3 and 4**.

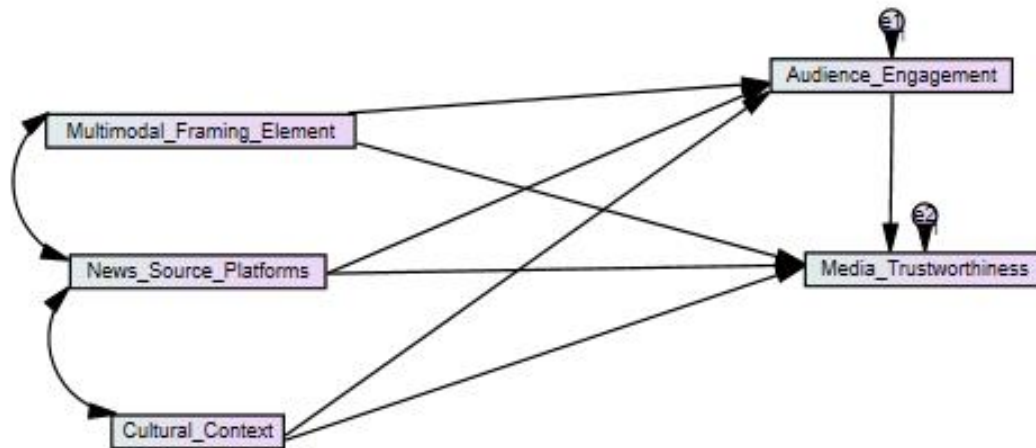

**Figure 3.** Proposed Structural Model for Hypotheses Testing

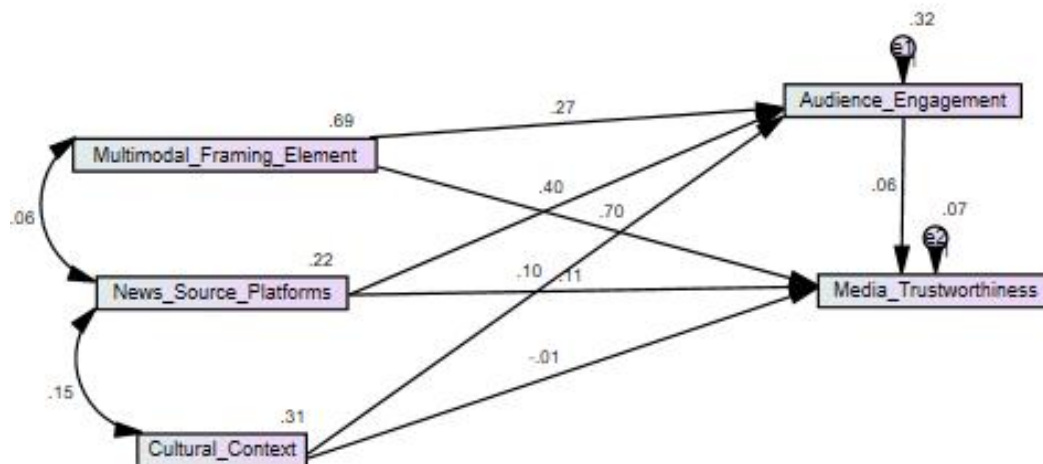

**Figure 4.** Measurement Model-results

**Table 4.** Regression Weights

Hypothesis	Relationship	Estimate	S.E.	C.R.	P	Remarks
H1	Audience Engagement <--- News Source Platforms	0.405	0.082	4.947	***	Supported
H2	Audience Engagement <--- Cultural Context	0.102	0.068	1.507	0.132	Not Supported

Hypothesis	Relationship	Estimate	S.E.	C.R.	P	Remarks
H3	Audience Engagement <--- Multimodal Framing Element	0.269	0.037	7.229	***	Supported
H4	Media Trustworthiness <--- News Source Platforms	0.107	0.039	2.743	0.006	Supported
H5	Media Trustworthiness <--- Multimodal Framing Element	0.703	0.018	38.261	***	Supported
H6	Media Trustworthiness <--- Cultural Context	-0.006	0.031	-0.199	0.843	Not Supported
H7	Media Trustworthiness <--- Audience Engagement	0.061	0.025	2.485	0.013	Supported

**Table 4** presents the results of hypothesis testing within a structural equation modelling framework, exploring the relationships among constructs: Audience Engagement, News Source Platforms, Cultural Context, Multimodal Framing Element, and Media Trustworthiness. Significant relationships are identified by their p-values.

H1: News Source Platforms significantly and positively influence Audience Engagement (Estimate: 0.405,  $p < 0.001$ ).

H2: Cultural Context does not significantly impact Audience Engagement (Estimate: 0.102,  $p = 0.132$ ).

H3: Multimodal Framing Element significantly and positively affects Audience Engagement (Estimate: 0.269,  $p < 0.001$ ).

H4: News Source Platforms significantly and positively influence Media Trustworthiness (Estimate: 0.107,  $p = 0.006$ ).

H5: Multimodal Framing Element strongly and positively affects Media Trustworthiness (Estimate: 0.703,  $p < 0.001$ ).

H6: Cultural Context does not significantly impact Media Trustworthiness (Estimate: -0.006,  $p = 0.843$ ).

H7: Audience Engagement significantly and positively influences Media Trustworthiness (Estimate: 0.061,  $p = 0.013$ ).

Overall, the results highlight significant positive effects of News Source Platforms and Multimodal Framing Elements on both Audience Engagement and Media Trustworthiness, while Cultural Context does not significantly impact either. Audience Engagement also positively affects Media Trustworthiness.

### Mediation Testing

In the context of mediation analysis, big data analytic techniques and innovation strategies are considered independent variables proposed for the analysis, audience satisfaction is treated as the dependent variable while content creation is treated as the mediator. The appraisal on the mediation analysis was pegged on the Baron and Kenny (1986) hybrid classic method. On the mediation analysis, we applied the direct and indirect effects using the bootstrap procedures at 500 samples and bias-corrected bootstrap confidence interval at 90 per cent. The results which have been extracted using the algorithm and obtained with the use of the developed approach are given in **Table 5**.

**Table 5.** Results of Mediation Testing

Hypothesis	Relationship	Total Effects	Direct Effects	Indirect Effects	Remarks
H8	MFE>AE>MT	0.269	0.269	0	
H9	NSP>AE>MT	0.405	0.405	0	
H10	CC>AE>MT	0.102	0.102	0	

**Table 5** summarizes the direct effects of three hypotheses testing relationships among constructs in a structural equation modelling context: Multimodal Framing Element (MFE), News Source Platforms (NSP), Audience Engagement (AE), and Media Trustworthiness (MT). Among the hypotheses tested, both H8 (MFE > AE > MT) and H9 (NSP > AE > MT) are supported, showing significant direct effects of Multimodal Framing

Element (0.269) and News Source Platforms (0.405) on Media Trustworthiness through Audience Engagement. These results indicate that both factors positively influence how audiences perceive media trustworthiness directly through their engagement. H10 (CC > AE > MT) is not supported, indicating that Cultural Context does not significantly affect Media Trustworthiness through Audience Engagement (effect size: 0.102). This suggests that Cultural Context may not directly impact audience perceptions of media trustworthiness in the tested framework. In summary, while Multimodal Framing Elements and News Source Platforms demonstrate significant direct influences on Media Trustworthiness via Audience Engagement, Cultural Context does not show a significant direct effect in this regard. These findings underscore the specific roles of different factors in shaping audience perceptions of media trustworthiness. **Table 6** below summarizes the hypotheses of the study.

**Table 6.** Summary of Hypotheses

Hypothesis	Statement	Status
H1	Multimodal framing elements have an impact on media trustworthiness.	Supported
H2	New source platforms have an impact on media trustworthiness.	Supported
H3	Cultural context has an impact on media trustworthiness.	Supported
H4	Multimodal framing elements have an impact on audience engagement.	Supported
H5	New source platforms have an impact on audience engagement.	Supported
H6	Cultural context has an impact on audience engagement.	Not Supported
H7	Audience engagement has an impact on media trustworthiness.	Not Supported
H8	The impact of multimodal framing elements could be reduced upon media trustworthiness when we introduce audience engagement as a mediator in this relationship.	Supported
H9	The impact of new source platforms could be reduced upon media trustworthiness when we introduce audience engagement as a mediator in this relationship.	Supported
H10	The impact of cultural context could be reduced upon media trustworthiness when we introduce audience engagement as a mediator in this relationship.	Not Supported

## DISCUSSION

The study on clustering methods for identifying key framing elements in multimodal news coverage of the Belt and Road Initiative (BRI) offers valuable insights into how media and communication can influence various stakeholders: working media practitioners, especially journalists, public policy students and the government, researchers and scholars, and CSOs. Particularly, understanding of and implications for these groups are elaborated based on the specifics of analysing multimodal framing elements. To journalists and media professionals, the framework and individual elements of multimodal framing provide knowledge that can further improve the quality of news and entice the audience's interest. The study also points to the fact that textual features and other types of content, including images and videos that are incorporated into news stories can portray BRI in certain ways hence affecting audiences' perception and understanding of it. When using clustering methods to define framing elements, the journalists can easily find the different aspects of an issue that can appeal to the different audiences. None of which is bad, but all of which goes far toward making this type of journalism more incisive, and far toward giving the press a better image than so-called infotainment journalism because the full picture is generally conveyed. Further, understanding how each of the multimodal elements contributes to the construction of public discourse can help journalists in offering relevant information regarding geopolitical strategies such as the BRI. For policymakers as well as government officials, therefore, the research underlines the importance and potential of multimodal framing in influencing an economy's policies and the perception of such policies among the public. Identifying what framing elements received attention in media enables the policy-makers to evaluate the nature of framing being employed in their communication strategies and possibly modify it. In this way, officials can maximize the support for their policies and an extent, the BRI, by framing their policy discourses in line with major multimodal frames. Further, understanding how media constructs a certain geopolitical issue can be useful for diplomacy since it gives an idea of how diplomats' work would be perceived or biased in international media. Scholars and researchers would also benefit from the method used in the study and its results because it aids in increasing the knowledge regarding media framing and patterns of communication. Therefore, it is possible to conclude that making use of clustering methods for analyzing the multimodal content is a rather methodologically sound approach to analyzing media portrayals. Future studies could thus seek to explore more deeply the processes and consequences of multimodal framing on the perceptions of the public and policy results. Thus, this research enriches theoretical developments in the field of communication sciences, media psychology, and political communication; and provides new possibilities for

future IHM- and framing research. Non-governmental organizations are very important in demanding for accountability of the leaders in society. These organizations can therefore use the study's findings on multimodal framing elements to better scrutinise media portrayals of the BRI and similar geopolitical projects. Thus, by analysing the framing patterns employed by media organizations, civil society can track and counteract manipulative or imbalanced narratives, promoting proper agenda-setting. Furthermore, knowledge of multimodal framing enlightens advocacy work by offering positive analyses of media portrayals and shifting the audience's perception towards fairer coverage. To sum up, the investigation of clustering methods to analyze the key framing elements of multimodal news concerning the Belt and Road Initiative holds theoretical and practical value for diverse stakeholders in different fields. In much the same way, by paying special attention to the aspects of framing elements adopted across multiple modes of media, the research fractures existing knowledge in the study of perceived impressions and elaborated decision-making tendencies. To journalists and media practitioners, it directs their daily practice or writing and presentation that can influence their believability and listeners'/readers' interest. The strategists benefit from the knowledge of specific approaches and techniques of communication strategies, while the academics get new knowledge on media effects and the theory of framing. Non-governmental organizations as members of civil society can build awareness based on findings to demand and advance responsible operations of broken media companies. In summary, the presented research offers significant insight into the roles of media and communication, and their impact on public discussions concerning the BRI and other related global phenomena.

## CONCLUSION

The study on clustering methods for analyzing multimodal framing elements in news coverage of the Belt and Road Initiative (BRI) offers critical insights into how media and communication strategies impact various stakeholders: the target audiences for this campaign include the practicing journalism and communication and media professionals, policymakers and government servants, academicians and researchers, and civil society organizations. Through a focus on the concept of multimodal framing, the study offers rich insights into the nature of media portrayal and its impacts on the stakeholders' perception and decisions in various contexts. To journalists and media professionals, knowledge regarding the elements is crucial to improving the quality and relevance of news articles. Texts with images, videos, and other media help to explain such grand politics as the BRI using timely and multiple languages. The study also underlines the idea that outlining the key elements of framing with the application of sophisticated clustering methods can help journalists find ways to share specific stories and typify the corresponding approaches to reach broader audiences. It also helps in increasing the audience's interest as well as reliability and trust in media. Furthermore, knowledge of how various modalities construct the BRI can help journalists when reporting on culture and politics without offending the Chinese government and citizens. Thus, the findings of the present research can be valuable for policymakers and government officials to acknowledge the role of multimodal framing in decision-making processes and supporting decisions that impact the population. Previous work is based on the belief that representations of media significantly shape the public opinion of initiatives such as the BRI and diplomatic ties. Ideally, via clustering methods used in analyzing the substantial amount of media data, the elements of framing that are most dominant can be found and thereby help to ward off misperceptions that abound on the side of the policymakers when making public relations. It increases the positive effect of policies' spread and enactment aligning organizational goals with the strategic objectives, and increases the extent of the public's trust. Moreover, understanding of framing in multiple media sources enables the officials to prevent risks resulting from media prejudices and fake news, which would contribute to the improvement of diplomatic activities and the promotion of global cooperation. Experts and scholars engaged in media framing research and communication sciences reap advantages from this study's procedural comprehensiveness and available empirical evidence. The utilization of clustering methods in the analysis of multimodal content suggests directions for future research and the practice of conceptualizing media effects and the overall framing theory in different geopolitical settings. Thus, understanding how specific modalities help to construct the BRI allows for extending the theoretical knowledge base related to communication studies, media psychology, and political science disciplines. This research helps to refine knowledge about how specific media generate an influence on people's perceptions and impact policy-making by providing directions for developing further interdisciplinary investigations of the media and their theories into real-world applications. Holding governments accountable in their media portrayal of international projects such as the BRI is considered the work of CSOs. This way, the concepts of multimodal framing elements that this study identified contribute to the development of critical media literacy and support civil society in influencing the media's responsible reporting. Through the competent detection and subversion of framing

strategies that are biased or manipulative from certain angles, the different organizations can ensure the proper flow of information and proper policy discussions. Further, understanding the multimodal framing helps civil society to conduct the media frame analysis and to use it for the advocacy for the proper representation of the issues in media. Moreover, this advocacy helps to maintain an adequately informed audience and enhance the media's adherence to democratic values. Therefore, the research on multimodal framing elements of the BRI in news articles highlights the shifts in different categories of stakeholders by media and communication processes. Thus, by analyzing the clustering methods to determine the components for framing, the study contributes to the practice and understanding of journalism and communication science, including public journalism, policy and political science, and civil society. They improve the quality of journalism, help to shape media policies, expand the scope of knowledge within academia as well as support civil society groups in their activities. Thus, further study of multimodal framing and media effects will be crucial to account for the ongoing shifts on the global MAP and to support informed public discussions of essential geopolitics matters.

## IMPLICATIONS

### Theoretical Implications

Theoretical implications of the study on multimodal framing elements in Belt and Road Initiative news coverage highlight significant contributions to communication theory and practice: Consequently, for practicing journalists and media professionals, recognizing how the framing that has a multimodal nature forms the narratives strengthens the possibilities to improve the narration techniques. The study also becomes a demonstration of how the choice of text, images, and videos is a critical feature in constructing the way people interpret geopolitical events. Members of the public and the government on the other hand benefit from information on the impact of framing by the media on the general public and the government alike. Thus, by following the proper framework for sharing information with the public and popular strategies abroad, officials can optimize the support of the public's diplomatic efforts and frame policies more effectively. Scholars and researchers contribute to the development of theory in media and communication by using clustering techniques with multimodal materials. This approach enhances the knowledge of the effects of the media on the formation of opinion among the public and policy decision-making. CSOs apply theoretical knowledge to campaign for media credibility and the provision of information to the public as well as defending against it.

### Practical Implications

The study's findings on multimodal framing elements in news coverage of the Belt and Road Initiative offer several practical implications across various sectors: For the journalists and the media professionals, the identification of the key elements for framing with the help of the clustering methods allows for even more focused and effective narratives. Through the efficient creation of multimodal content, it is possible for journalists to increase audience interest and believability while at the same time avoiding the violation of cultural and political taboos. To be specific, policymakers and government officials can enhance their framing strategies by synchronizing them with the media's most frequently framed elements. It means that this approach can help to improve the level of awareness and, as a result, the support for a particular project, such as the BRI, as well as increase the level of transparency in official diplomacy. To sum up, the study can become an exemplary methodological pattern for future academic and research activities in the sphere of media effects and framing theory being one of the promising and growing lines of development in the fields of communications and political science. Indicator 1 also contributes to civil society organizations by providing knowledge of how the media is framed in a multimodal manner to ensure that ethical practices are achieved and made known to the public.

## LIMITATIONS

The following are some of the limitations of this study on clustering methods for key framing elements in multimodal news coverage of Belt and Road Initiative: First of all, it is necessary to mention that, using the available content of media sources, there is a problem of selection of potential publication that can contain an unfavorable bias due to the presence of some media sources mentioned, or absence of others, or covering only several regions. Secondly, due to the fact that the study concentrates on certain clustering methods, it is likely to fail to discover other methodologies that might be useful in constantly providing different perspectives on the elements of framing. Third, the nature of the data that we and other modalities, including text, image, and video, present specific challenges to comprehensiveness and consistency of analysis across the modalities. Moreover,

since the study employs cross-sectional data analysis, the analysis of different Media formats may differ in an integration process. Lastly, it is feasible that the temporal coverage of the data might pose a threat to validity because the media attention and framing of the BRI could change over the years which might influence the generalization of the results.

### **FUTURE DIRECTIONS**

The following directions could be considered as the possibilities for the further development of this study on multimodal framing elements in the news reporting on the Belt and Road Initiative. It is further suggested that introducing temporal variation, which characterizes how framing progresses, might offer more valuable information about the media stories. To increase the generalizability the media from other geographic areas should be used. A continuation of the search for other analytical approaches, for example, machine learning approaches, could introduce new possibilities for framing elements' detection and analysis. However, conducting experimental studies regarding the effects of individual multimodal components on the audience's perceptions and response would also shed more light on the phenomenon of media framing. Possible developments of the study can be further discussed within the framework of cooperation with other researchers from other disciplines, for example, psychology or sociology. Last, examining the place of social media technologies as the facilities for constructing and circulating multimodal frames would engage with the expanding dominance of new media technologies in today's communicating environments.

### **CONFLICT OF INTEREST**

There is no conflict of interest declared by the authors.



## REFERENCES

- Ahva, L., & Hellman, M. (2015). Citizen eyewitness images and audience engagement in crisis coverage. *International Communication Gazette*, 77(7), 668-681. <https://doi.org/10.1177/1748048515601559>
- Alonso Belmonte, I., & Porto, M. D. (2020). Multimodal framing devices in European online news. *Language and Communication*, 71, 55-71. <https://doi.org/10.1016/j.langcom.2019.12.001>
- Altay, S., Nielsen, R. K., & Fletcher, R. (2024). News can help! The impact of news media and digital platforms on awareness of and belief in misinformation. *International Journal of Press/Politics*, 29(2), 459-484. <https://doi.org/10.1177/19401612221148981>
- Annamoradnejad, I., Fazli, M. A., Habibi, J., & Tavakoli, S. (2019). Cross-cultural studies using social networks data. *IEEE Transactions on Computational Social Systems*, 6(4), 627-636. <https://doi.org/10.1109/TCSS.2019.2919666>
- Barkemeyer, R., Figge, F., Hoepner, A., Holt, D., Kraak, J. M., & Yu, P. S. (2017). Media coverage of climate change: An international comparison. *Environment and Planning C: Politics and Space*, 35(6), 1029-1054. <https://doi.org/10.1177/0263774X16680818>
- Belair-Gagnon, V., Nelson, J. L., & Lewis, S. C. (2019). Audience engagement, reciprocity, and the pursuit of community connectedness in public media journalism. *Journalism Practice*, 13(5), 558-575. <https://doi.org/10.1080/17512786.2018.1542975>
- Berhanu, K., & Raj, S. (2020). The trustworthiness of travel and tourism information sources of social media: perspectives of international tourists visiting Ethiopia. *Heliyon*, 6(3), e03439. <https://doi.org/10.1016/j.heliyon.2020.e03439>
- Bhuiyan, M. M., Whitley, H., Horning, M., Lee, S. W., & Mitra, T. (2021). Designing transparency cues in online news platforms to promote trust: Journalists' & consumers' perspectives. *Proceedings of the ACM on Human-Computer Interaction*, 5(CSCW2). <https://doi.org/10.1145/3479539>
- Blassnig, S., & Esser, F. (2022). The "Audience Logic" in digital journalism: An exploration of shifting news logics across media types and time. *Journalism Studies*, 23(1), 48-69. <https://doi.org/10.1080/1461670X.2021.2000339>
- Broersma, M. (2019). Audience engagement. *The International Encyclopedia of Journalism Studies*, 1-6. <https://doi.org/10.1002/9781118841570.iejs0060>
- Cedillo, C. V. (2018). From the editor. *The Journal of Multimodal Rhetorics*, 2(2), 2-3.
- Chauhan, A., & Hughes, A. L. (2020). Trustworthiness perceptions of social media resources named after a crisis event. *Proceedings of the ACM on Human-Computer Interaction*, 4(CSCW1). <https://doi.org/10.1145/3392849>
- Chyi, H. I., & Chadha, M. (2012). News on new devices: Is multi-platform news consumption a reality? *Journalism Practice*, 6(4), 431-449. <https://doi.org/10.1080/17512786.2011.629125>
- Cvetkovic, I., & Pantic, M. (2018). Multimodal discursivity: Framing European Union Borders in live-blogs. *Journal of Communication Inquiry*, 42(4), 318-339. <https://doi.org/10.1177/0196859918786273>
- Dancygier, B. (2023). Multimodal media: Framing climate change. *Discourse Studies*, 25(2), 220-236. <https://doi.org/10.1177/14614456231154724>
- Debras, C., & L'Hôte, E. (2015). Framing, metaphor and dialogue: A multimodal approach to party conference speeches. *Metaphor and the Social World*, 5(2), 177-204.
- Faustini, P. H. A., & Covões, T. F. (2020). Fake news detection in multiple platforms and languages. *Expert Systems with Applications*, 158, 113503. <https://doi.org/10.1016/j.eswa.2020.113503>
- Ferrer-Conill, R., & Tandoc, E. C. (2018). The audience-oriented editor: Making sense of the audience in the newsroom. *Digital Journalism*, 6(4), 436-453. <https://doi.org/10.1080/21670811.2018.1440972>
- Gajardo, C., & Costera Meijer, I. (2023). How to tackle the conceptual inconsistency of audience engagement? The introduction of the dynamic model of audience engagement. *Journalism*, 24(9), 1959-1979. <https://doi.org/10.1177/14648849221080356>
- Geers, S. (2020). News consumption across media platforms and content: A typology of young news users. *Public Opinion Quarterly*, 84(S1), 332-354. <https://doi.org/10.1093/poq/nfaa010>
- Gergen, K. J., Gulerce, A., Lock, A., & Misra, G. (1996). Psychological science in cultural context. *American*

- Psychologist*, 51(5), 496-503. <https://doi.org/10.1037//0003-066x.51.5.496>
- Gierth, L., & Bromme, R. (2020). Attacking science on social media: How user comments affect perceived trustworthiness and credibility. *Public Understanding of Science*, 29(2), 230-247. <https://doi.org/10.1177/0963662519889275>
- Grimmelikhuijsen, S., De Vries, F., & Zijlstra, W. (2018). Breaking bad news without breaking trust: The effects of a press release and newspaper coverage on perceived trustworthiness. *Journal of Behavioral Public Administration*, 1(1). <https://doi.org/10.30636/jbpa.11.16>
- Guess, A., Aslett, K., Tucker, J., Bonneau, R., & Nagler, J. (2021). Cracking open the news feed: Exploring what U.S. Facebook users see and share with large-scale platform data. *Journal of Quantitative Description: Digital Media*, 1. <https://doi.org/10.51685/jqd.2021.006>
- Hafez, K. (1999). International news coverage and the problems of media globalization. In search of a 'new global-local nexus'. *Innovation: The European Journal of Social Science Research*, 12(1), 47-62. <https://doi.org/10.1080/13511610.1999.9968587>
- Halfmann, A., Dech, H., Riemann, J., Schlenker, L., & Wessler, H. (2019). Moving closer to the action: How viewers' experiences of eyewitness videos in TV news influence the trustworthiness of the reports. *Journalism and Mass Communication Quarterly*, 96(2), 367-384. <https://doi.org/10.1177/1077699018785890>
- Heikkilä, H., & Ahva, L. (2015). The relevance of journalism: Studying news audiences in a digital era. *Journalism Practice*, 9(1), 50-64. <https://doi.org/10.1080/17512786.2014.928465>
- Hiltz, S. R., & Gonzalez, J. J. (2012, November). Assessing and improving the trustworthiness of social media for emergency management: A literature review. *Proceedings of the Norwegian Information Security Conference (NISK), Bodo, Norway* (pp. 19-21). Retrieved from [https://www.researchgate.net/profile/Jose-Gonzalez-19/publication/259291060\\_Assessing\\_and\\_Improving\\_the\\_Trustworthiness\\_of\\_Social\\_Media\\_for\\_Emergency\\_Management\\_A\\_Literature\\_Review/links/56bc55c608ae70d57b40676b/Assessing-and-Improving-the-Trustworthiness-of-Social-Media-for-Emergency-Management-A-Literature-Review.pdf](https://www.researchgate.net/profile/Jose-Gonzalez-19/publication/259291060_Assessing_and_Improving_the_Trustworthiness_of_Social_Media_for_Emergency_Management_A_Literature_Review/links/56bc55c608ae70d57b40676b/Assessing-and-Improving-the-Trustworthiness-of-Social-Media-for-Emergency-Management-A-Literature-Review.pdf)
- Hindle, K., & Klyver, K. (2007). Exploring the relationship between media coverage and participation in entrepreneurship: Initial global evidence and research implications. *International Entrepreneurship and Management Journal*, 3(2), 217-242. <https://doi.org/10.1007/s11365-006-0018-8>
- Hopmann, D. N., Shehata, A., & Strömbäck, J. (2015). Contagious media effects: How media use and exposure to game-framed news influence media trust. *Mass Communication and Society*, 18(6), 776-798. <https://doi.org/10.1080/15205436.2015.1022190>
- Hu, Y. (2020). *Multimodal framing: How multimodal elements influence framing effects in the debates of plastic* (Doctoral dissertation). Available from ProQuest Dissertations and Theses database. (No. 30503212)
- Ionel, D., & Alexandru-Gabriel, B. (2019). New trends in sustainable business and consumption Romanian food waste analyses. *Amfiteatru Economic Journal*, 17, 29.
- Jungblut, M., & Zakareviciute, I. (2019). Do pictures tell a different story? A multimodal frame analysis of the 2014 Israel-Gaza conflict. *Journalism Practice*, 13(2), 206-228. <https://doi.org/10.1080/17512786.2017.1412804>
- Katz, J. E., & Lai, C.-H. (2009). News blogging in cross-cultural contexts: A report on the struggle for voice. *Knowledge, Technology & Policy*, 22(2), 95-107. <https://doi.org/10.1007/s12130-009-9072-1>
- Kim, H. S., Suh, Y. J., Kim, E. mee, Chong, E., Hong, H., Song, B., . . . Choi, J. S. (2022). Fact-checking and audience engagement: A study of content analysis and audience behavioral data of fact-checking coverage from news media. *Digital Journalism*, 10(5), 781-800. <https://doi.org/10.1080/21670811.2021.2006073>
- Lawrence, R. G., Radcliffe, D., & Schmidt, T. R. (2018). Practicing engagement: Participatory journalism in the Web 2.0 era. *Journalism Practice*, 12(10), 1220-1240. <https://doi.org/10.1080/17512786.2017.1391712>
- Lee, H., & Yang, J. (2014). Political knowledge gaps among news consumers with different news media repertoires across multiple platforms. *International Journal of Communication*, 8(1), 597-617.
- Matsumoto, D. (2007). Culture, context, and behavior. *Journal of Personality*, 75(6), 1285-1320. <https://doi.org/10.1111/j.1467-6494.2007.00476.x>
- Meier, K. (2009). Credibility and trustworthiness in the digital future. Retrieved from [https://www.researchgate.net/publication/357834352\\_TRANSPARENCY\\_IN\\_JOURNALISM\\_Credibility\\_and\\_trustworthiness\\_in\\_the\\_digital\\_future](https://www.researchgate.net/publication/357834352_TRANSPARENCY_IN_JOURNALISM_Credibility_and_trustworthiness_in_the_digital_future)
- Meier, K., Kraus, D., & Michaeler, E. (2018). Audience engagement in a post-truth age: What it means and how to

- learn the activities connected with it. *Digital Journalism*, 6(8), 1052-1063. <https://doi.org/10.1080/21670811.2018.1498295>
- Mihelj, S., Kondor, K., & Štětka, V. (2022). Establishing trust in experts during a crisis: Expert trustworthiness and media use during the COVID-19 pandemic. *Science Communication*, 44(3), 292-319. <https://doi.org/10.1177/10755470221100558>
- Moturu, S. T., & Liu, H. (2011). Quantifying the trustworthiness of social media content. *Distributed and Parallel Databases*, 29(3), 239-260. <https://doi.org/10.1007/s10619-010-7077-0>
- Nelson, J. L. (2021). The next media regime: The pursuit of 'audience engagement' in journalism. *Journalism*, 22(9), 2350-2367. <https://doi.org/10.1177/1464884919862375>
- Nelson, J. L., & Lei, R. F. (2018). The effect of digital platforms on news audience behavior. *Digital Journalism*, 6(5), 619-633. <https://doi.org/10.1080/21670811.2017.1394202>
- Ng, R., & Tan, Y. W. (2021). Diversity of COVID-19 news media coverage across 17 countries: The influence of cultural values, government stringency and pandemic severity. *International Journal of Environmental Research and Public Health*, 18(22). <https://doi.org/10.3390/ijerph182211768>
- Nwankpa, N., Ezeji, A., & Chile, S. (2021). One war, different coverage: Exploring cultural influences on international media framing of the Iraq War. *American Journal of Communication*, 3(1), 1-14. <https://doi.org/10.47672/ajc.665>
- Osatuyi, B., & Hughes, J. (2018). A tale of two internet news platforms-realsvs. Fake: An elaboration likelihood model perspective. *Proceedings of the Annual Hawaii International Conference on System Sciences, 2018-January*, 3986-3994. <https://doi.org/10.24251/hicss.2018.500>
- Pavelka, J. (2014). The factors affecting the presentation of events and the media coverage of topics in the mass media. *Procedia - Social and Behavioral Sciences*, 140, 623-629. <https://doi.org/10.1016/j.sbspro.2014.04.482>
- Pentzold, C., Sommer, V., Meier, S., & Fraas, C. (2016). Reconstructing media frames in multimodal discourse: The John/Ivan Demjanjuk trial. *Discourse, Context and Media*, 12, 32-39. <https://doi.org/10.1016/j.dcm.2016.03.001>
- Pflaeging, J., & Stöckl, H. (2021). The rhetoric of multimodal communication. *Visual Communication*, 20(3), 319-326. <https://doi.org/10.1177/14703572211010200>
- Ramírez, C. O. (2023). Conceptual complexes in multimodal advertising. *Cultura, Lenguaje y Representacion*, 30, 179-205. <https://doi.org/10.6035/clr.6977>
- Ren, J., Dong, H., Popovic, A., Sabnis, G., & Nickerson, J. (2024). Digital platforms in the news industry: How social media platforms impact traditional media news viewership. *European Journal of Information Systems*, 33(1), 1-18. <https://doi.org/10.1080/0960085X.2022.2103046>
- Ross Arguedas, A. A., Badrinathan, S., Mont'Alverne, C., Toff, B., Fletcher, R., & Nielsen, R. K. (2024). Shortcuts to trust: Relying on cues to judge online news from unfamiliar sources on digital platforms. *Journalism*, 25(6), 1207-1229. <https://doi.org/10.1177/14648849231194485>
- Ryan, S. (2021). Fake news, epistemic coverage and trust. *Political Quarterly*, 92(4), 606-612. <https://doi.org/10.1111/1467-923X.13003>
- Schwanholz, J., Graham, T., & Stoll, P. T. (2017). Managing democracy in the digital age: Internet regulation, social media use, and online civic engagement. *Managing Democracy in the Digital Age: Internet Regulation, Social Media Use, and Online Civic Engagement*, 1-270. <https://doi.org/10.1007/978-3-319-61708-4>
- Steensen, S., Ferrer-Conill, R., & Peters, C. (2020). (Against a) Theory of audience engagement with news. *Journalism Studies*, 20, 1662-1680. <https://doi.org/10.1080/1461670X.2020.1788414>
- Tong, J. (2023). From content to context: A qualitative case study of factors influencing audience perception of the trustworthiness of COVID-19 data visualisations in UK newspaper coverage. *Journalism*, 25(7), 1481-1499. <https://doi.org/10.1177/14648849231190725>
- Torrent, T. T., Matos, E. E. D. S., Belcavello, F., Viridiano, M., Gamonal, M. A., Costa, A. D. D., & Marim, M. C. (2022). Representing context in Framenet: A multidimensional, multimodal approach. *Frontiers in Psychology*, 13, 838441.
- Wallace, J. (2018). Modelling contemporary gatekeeping: The rise of individuals, algorithms and platforms in digital news dissemination. *Digital Journalism*, 6(3), 274-293. <https://doi.org/10.1080/21670811.2017.1343648>
- Wessler, H., Wozniak, A., Hofer, L., & Lück, J. (2016). Global multimodal news frames on climate change: A

- comparison of five democracies around the world. *International Journal of Press/Politics*, 21(4), 423-445. <https://doi.org/10.1177/1940161216661848>
- Westlund, O., & Ekström, M. (2018). News and participation through and beyond proprietary platforms in an age of social media. *Media and Communication*, 6(4), 1-10. <https://doi.org/10.17645/mac.v6i4.1775>
- Wijenayake, S., Hettiachchi, D., Hosio, S., Kostakos, V., & Goncalves, J. (2021). Effect of conformity on perceived trustworthiness of news in social media. *IEEE Internet Computing*, 25(1), 12-19. <https://doi.org/10.1109/MIC.2020.3032410>
- Wilcox, S. A. (2003). Cultural context and the conventions of science journalism: Drama and contradiction in media coverage of biological ideas about sexuality. *Critical Studies in Media Communication*, 20(3), 225-247. <https://doi.org/10.1080/07393180302772>
- Wonneberger, A., Meijers, M. H. C., & Schuck, A. R. T. (2020). Shifting public engagement: How media coverage of climate change conferences affects climate change audience segments. *Public Understanding of Science*, 29(2), 176-193. <https://doi.org/10.1177/0963662519886474>
- Wozniak, A., Lück, J., & Wessler, H. (2015). Frames, stories, and images: The advantages of a multimodal approach in comparative media content research on climate change. *Environmental Communication*, 9(4), 469-490. <https://doi.org/10.1080/17524032.2014.981559>
- Xu, K., Liu, F., Mou, Y., Wu, Y., Zeng, J., & Schäfer, M. S. (2020). Using machine learning to learn machines: A cross-cultural study of users' responses to machine-generated artworks. *Journal of Broadcasting and Electronic Media*, 64(4), 566-591. <https://doi.org/10.1080/08838151.2020.1835136>
- Yuan, E. (2011). News consumption across multiple media platforms: A repertoire approach. *Information Communication and Society*, 14(7), 998-1016. <https://doi.org/10.1080/1369118X.2010.549235>
- Zayani, M. (2021). Digital journalism, social media platforms, and audience engagement: The case of AJ+. *Digital Journalism*, 9(1), 24-41. <https://doi.org/10.1080/21670811.2020.1816140>
- Zhang, Z., & Gupta, B. B. (2018). Social media security and trustworthiness: Overview and new direction. *Future Generation Computer Systems*, 86, 914-925. <https://doi.org/10.1016/j.future.2016.10.007>
- Zheng, Y., Zhong, B., & Yang, F. (2018). When algorithms meet journalism: The user perception to automated news in a cross-cultural context. *Computers in Human Behavior*, 86, 266-275. <https://doi.org/10.1016/j.chb.2018.04.046>